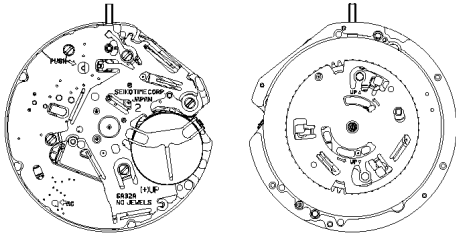

# PARTS CATALOGUE/TECHNICAL GUIDE

## Cal. 6A32A

Brand		<b>SEIKO</b>
Cal. No.		<b>6A32A</b>
Movement		
Movement size (mm)	Outside diameter	Ø 27.8
	Casing diameter	Ø 27.3
	Height ( Including battery portion )	3.69
Time indication		3 hands (hour, minute and second hands)
Driving system		Step motor (hour, minute and second hands) Electronic driving motor for calendar indication
Additional mechanism		<ul style="list-style-type: none"> <li>● Fully automatic calendar (No calendar adjustment required at the end of a month, nor for a leap year)</li> <li>● Initial position adjustment (Position adjustment for the second hand and date)</li> <li>● Train wheel setting device</li> <li>● Electronic circuit reset switch</li> <li>● Battery life indicator</li> </ul>
Crown Operation	Normal position	Free
	First click position	Date, month, year adjustments (by turning the crown either clockwise or counterclockwise) (electronic system)
	Second click position	Hand position adjustments, Second regulation, Reset switch
Loss/gain		Monthly rate at normal temperature range: less than 20 seconds
Regulation system		Nil.
Measuring gate by quartz tester		Use 10-second gate.
Battery	Battery No.	Silver Oxide Battery SB-AP (SR927SW)
	Voltage	1.55 V
	Battery life	Approximately 4 years
Jewels		Nil.

SEIKO WATCH CORPORATION

# PARTS CATALOGUE

Cal. 6A32A

● Order of disassembly for the hands, dial and wheels on the back side

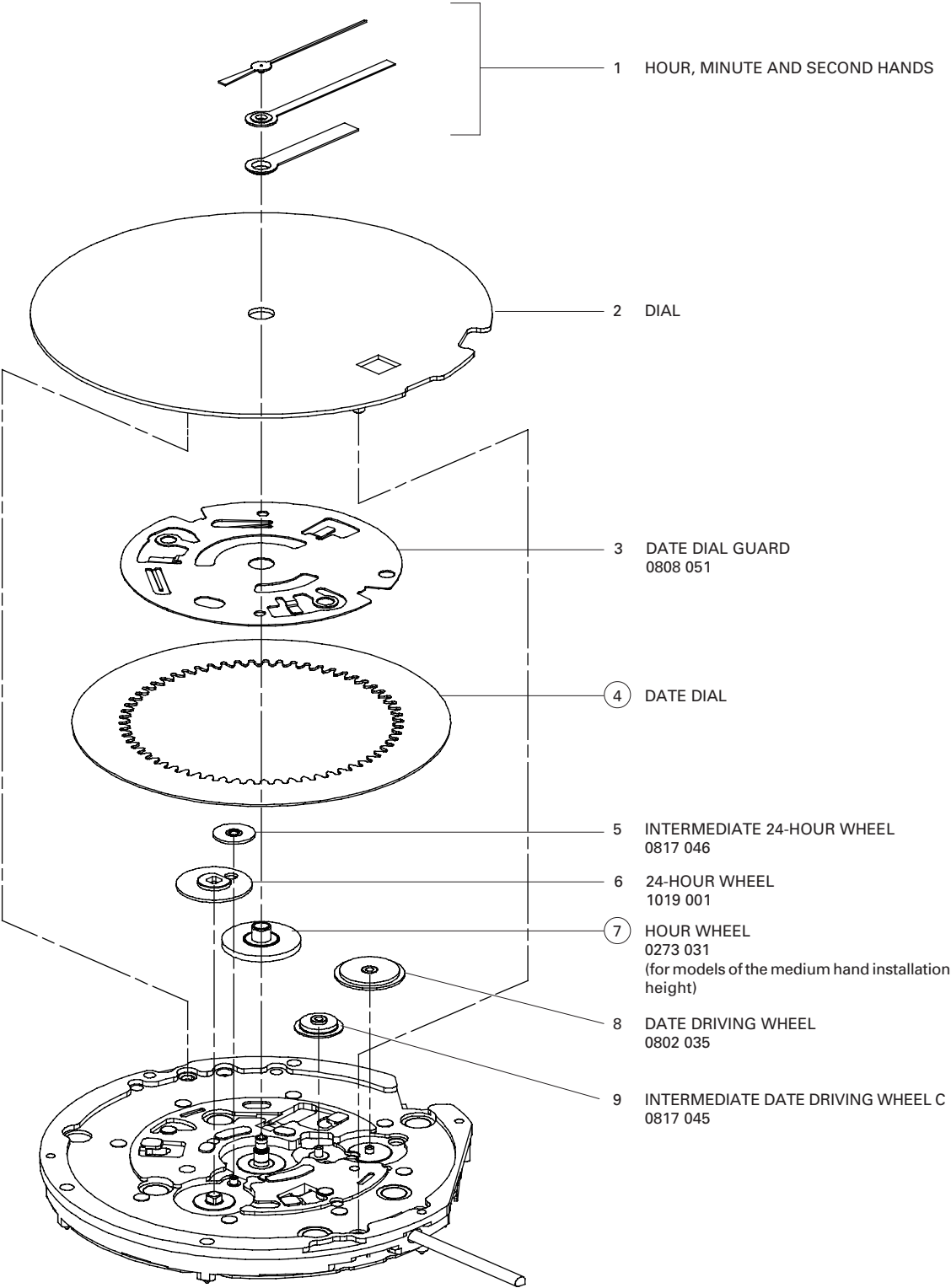

● Order of disassembly for the battery, circuit block, wheels on the front side and switching mechanism

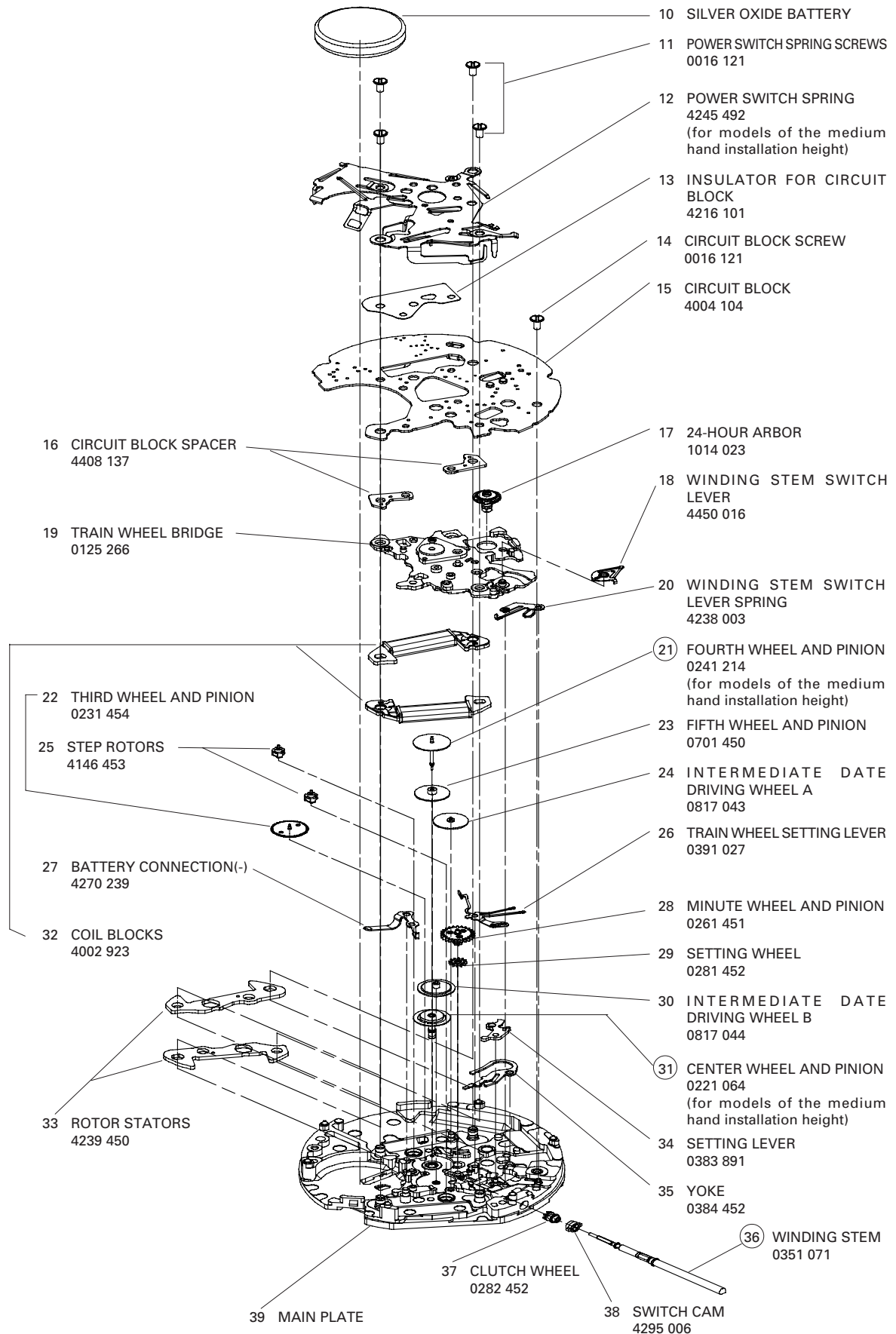

# PARTS CATALOGUE

Cal. 6A32A

## [Parts list]

There are different types of parts which are determined based on the case design or hand installation height. To choose the appropriate one, refer to "WATCH PARTS CATALOGUE CD-ROM."

No.	PARTS NAME	PARTS CODE	Number of parts	REMARK
3	DATE DIAL GUARD	0808 051	1	
4	DATE DIAL (INCOMPLETE)	-	1	Refer to WATCH PARTS CATALOGUE CD-ROM.
5	INTERMEDIATE 24-HOUR WHEEL	0817 046	1	
6	24-HOUR WHEEL	1019 001	1	
7	HOUR WHEEL	0273 031	1	For models of the medium hand installation height
8	DATE DRIVING WHEEL	0802 035	1	
9	INTERMEDIATE DATE DRIVING WHEEL C	0817 045	1	
10	SILVER OXIDE BATTERY	-	1	SB-AP (SR927SW)
11	POWER SWITCH SPRING SCREW	0016 121	4	(11)(12)(13)(14)
12	POWER SWITCH SPRING	4245 492	1	For models of the medium hand installation height Inprinted mark "2"
13	INSULATOR FOR CIRCUIT BLOCK	4216 101	1	
14	CIRCUIT BLOCK SCREW	0016 121	1	(33)
15	CIRCUIT BLOCK	4004 104	1	
16	CIRCUIT BLOCK SPACER	4408 137	2	
17	24-HOUR ARBOR	1014 023	1	
18	WINDING STEM SWITCH LEVER	4450 016	1	
19	TRAIN WHEEL BRIDGE	0125 266	1	
20	WINDING STEM SWITCH LEVER SPRING	4238 003	1	
21	FOURTH WHEEL AND PINION	0241 214	1	For models of the medium hand installation height
22	THIRD WHEEL AND PINION	0231 454	1	
23	FIFTH WHEEL AND PINION	0701 450	1	
24	INTERMEDIATE DATE DRIVING WHEEL A	0817 043	1	
25	STEP ROTOR	4146 453	2	
26	TRAIN WHEEL SETTING LEVER	0391 027	1	
27	BATTERY CONNECTION(-)	4270 239	1	
28	MINUTE WHEEL AND PINION	0261 451	1	
29	SETTING WHEEL	0281 452	1	
30	INTERMEDIATE DATE DRIVING WHEEL B	0817 044	1	
31	CENTER WHEEL AND PINION	0221 064	1	For models of the medium hand installation height
32	COIL BLOCK	4002 923	2	
33	ROTOR STATOR	4239 450	2	
34	SETTING LEVER	0383 891	1	
35	YOKE	0384 452	1	
36	WINDING STEM	0351 071	1	Refer to WATCH PARTS CATALOGUE CD-ROM.
37	CLUTCH WHEEL	0282 452	1	
38	SWITCH CAM	4295 006	1	
39	MAIN PLATE	0100 293	1	
	TOTAL NUMBER OF PARTS (TO BE ASSEMBLED)		44	

## DISASSEMBLY

### 1. How to pull out the winding stem

With the crown at the normal position, using a tool such as a pair of tweezers, press down the designated area indicated by "PUSH" (as shown in the illustration on the right) of the setting lever. And then, pull out the winding stem to which the crown is attached.

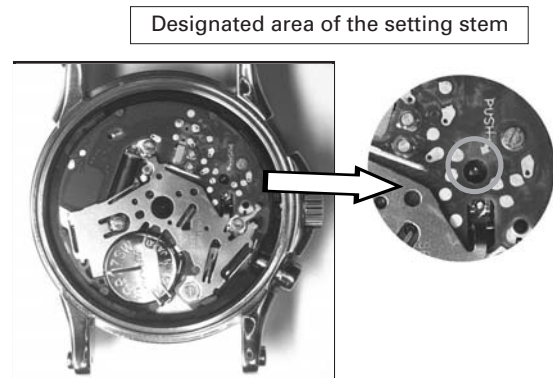

### 2. How to remove the hands

Reassemble the winding stem. Turn the hour, minute and second hands to align them pointing in the same direction, and then remove them all together.

When using a tool such as a hand remover, exercise care so as not to damage the calendar frame or the dial with the tool during the hand removing process. Align the hands together at a position where you can avoid touching the calendar frame with the tool, in consideration of the orientation of the calendar frame on the dial.

To prevent damage to the surface of the hands and dial, slip a thin plastic sheet between the dial and remover.

### 3. How to remove the dial

From the lateral side at the foot positions of the dial (indicated in the illustration on the right), insert the tip of a driver or tweezers into the gap between the lower surface of the dial and main plate to gradually lift up the dial and remove it.

While doing this, make sure to lift the dial up gradually one side after another. Lifting the dial up only from one side may break the foot of the dial.

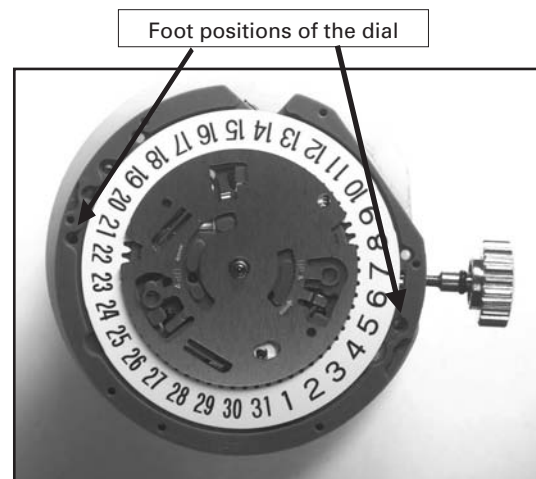

**For disassembly and reassembly, make sure to use the all-purpose movement holder.**

## Installation positions • Lubrication points • Remarks

<p>Reassembly (1) Lubricate the main plate.</p>	<p>※ Make sure to lubricate the exact lubrication points with an adequate amount of the correct type of oil.</p> <p>●▶ normal quantity</p>
---	--

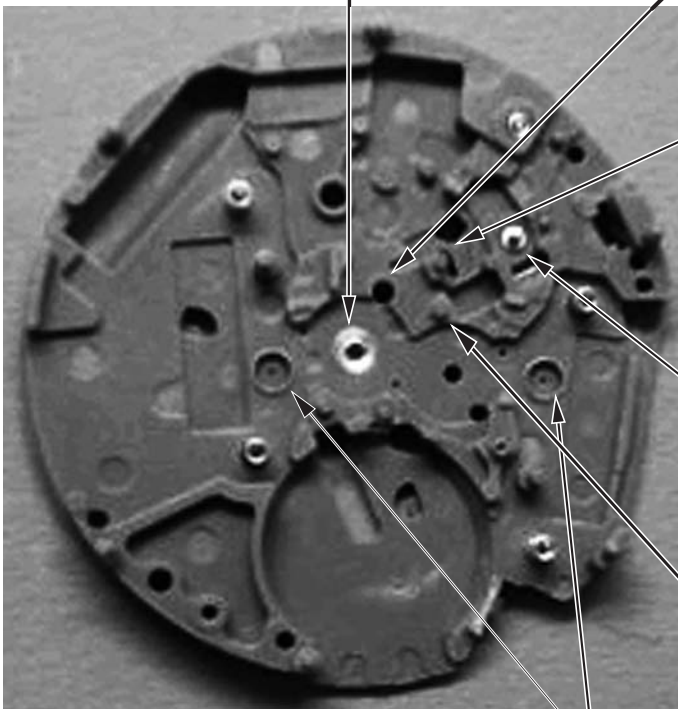

Main plate (back side)

① Center pipe (AO-3)

② Lower guide hole of the minute wheel and pinion (AO-3)

③ Guide pin of the train wheel setting lever (AO-3)

④ Pin of the setting lever (AO-3)

⑤ Pin of the setting wheel (AO-3)

⑥ & ⑦ Lower holes of the rotor (AO-2)

## Installation positions • Lubrication points • Remarks

<p>Reassembly (2) Lubricate the switching mechanism.</p>	<p>※ Install the parts in the number order shown in the illustration below, paying attention to the following: mounting positions, direction of mounting, type of oil, lubrication point(s) and amount of lubrication.</p> <p>● normal quantity      ●● liberal quantity</p>
--	--

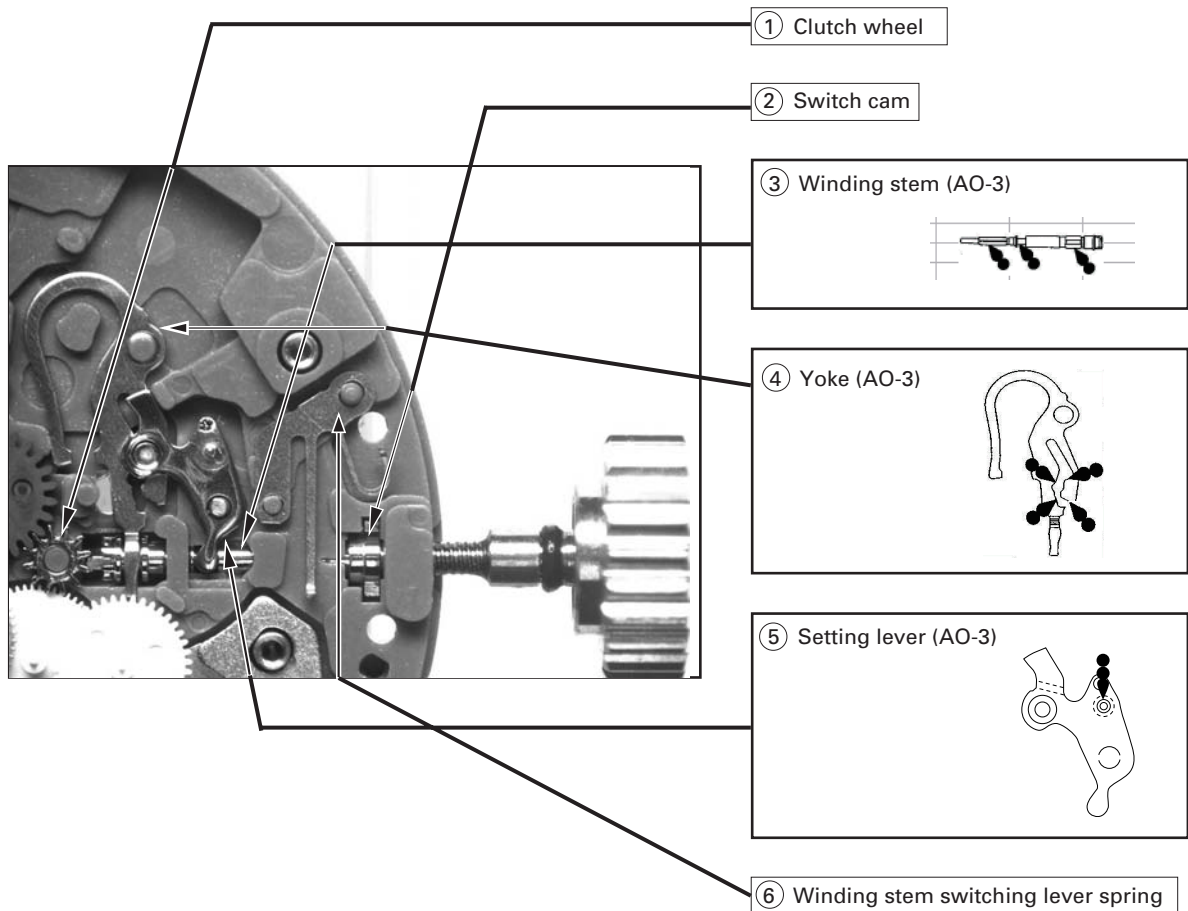



## Installation positions • Lubrication points • Remarks

<p>Reassembly (3) Reassemble the wheels and train wheel bridge.</p>	<p>※ Install the parts in the number order shown in the illustration below, paying attention to the following: mounting positions, direction of mounting, type of oil, lubrication point(s) and amount of lubrication. ●▶ normal quantity</p>
---	---

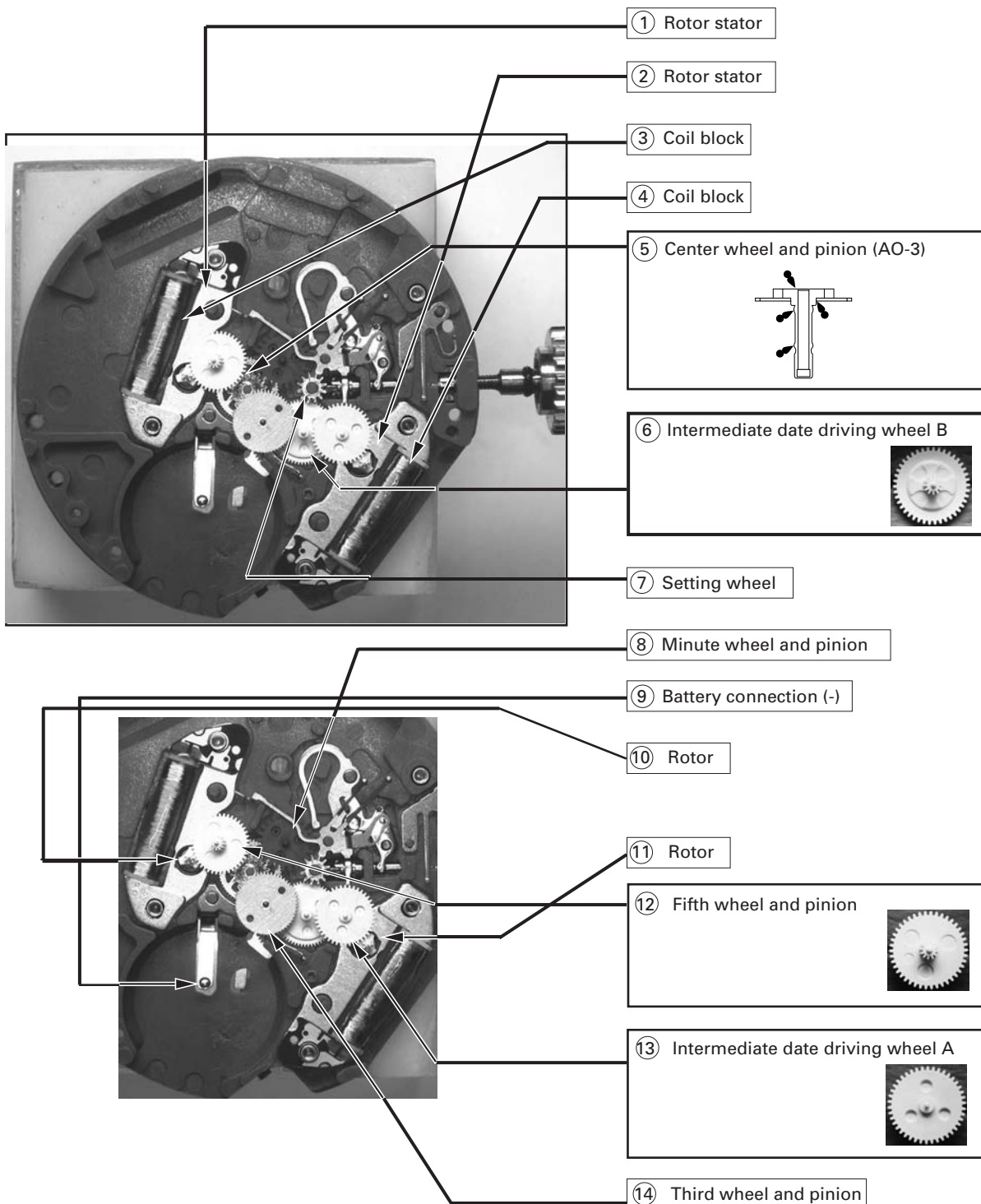



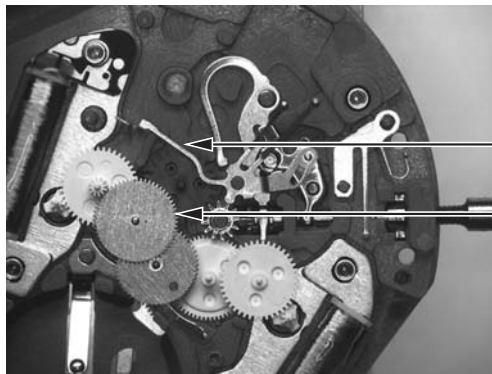

⑮ Train wheel setting lever

⑯ Fourth wheel and pinion (AO-3)

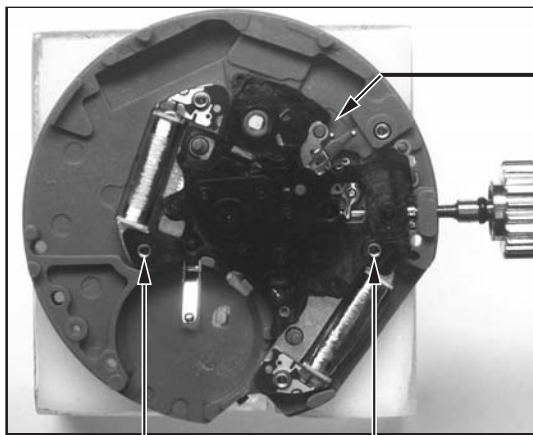
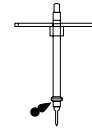

⑰ Train wheel bridge

Positions of the guide pins for train wheel bridge

When handling the plastic parts, use a pair of tweezers to securely hold them, paying attention not to damage the teeth or pinions.

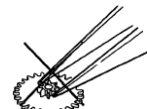
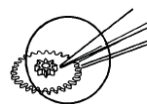

When holding the coil block, be careful not to touch the coil board or coil wire.

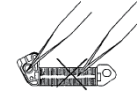
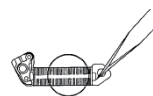

## Installation positions • Lubrication points • Remarks

Reassembly (4)  
Lubricate the train wheel  
bridge.

\* Make sure to lubricate the exact lubrication points with an adequate amount of the correct type of oil.

●▶ normal quantity

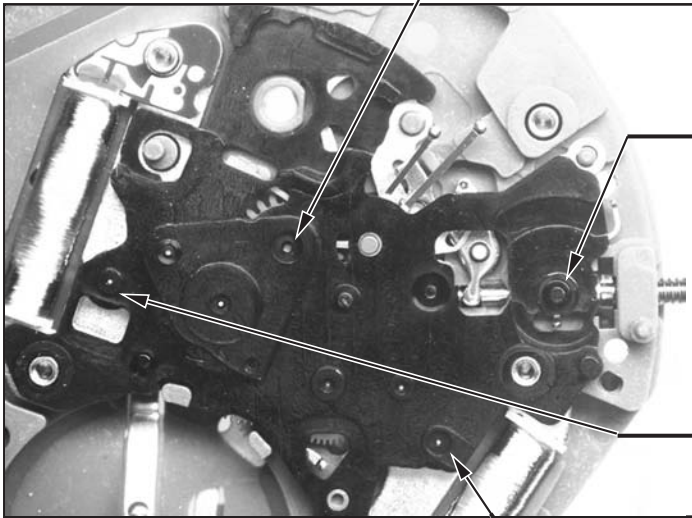

① Minute wheel and pinion (AO-3)

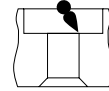

② Pin for crown switch (AO-3)

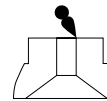

③ Upper pivot of the rotor (AO-2)

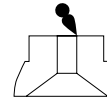

④ Upper pivot of the rotor (AO-2)

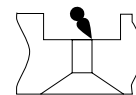

## Installation positions • Lubrication points • Remarks

<p>Reassembly (5) Reassemble the circuit block spacer and winding stem switch lever.</p>	<p>※ Install the parts in the number order shown in the illustration below, paying attention to the following:                      mounting positions,                      direction of mounting,                      type of oil, lubrication point(s) and amount of lubrication.</p> <p>●▶ normal quantity</p>
--	---

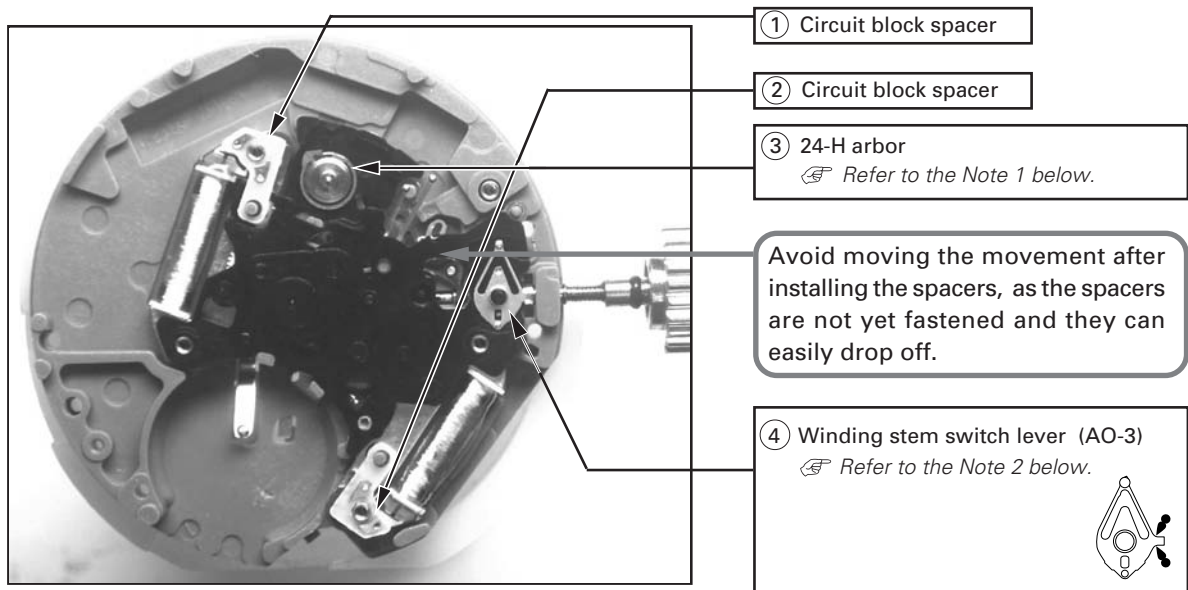

☞ Note 1

**Installation position of the 24-H arbor**

Place the 24-H arbor in the position where it does not cover the holes indicated in the illustration on the left, as the switch pins of the circuit block will be inserted into those holes.

☞ Note 2

**Remarks on installation of the winding stem switch lever**

Make sure that the winding stem switch lever does not overlap the tip of the winding stem switch lever spring.

## Installation positions • Lubrication points • Remarks

<p>Reassembly (6) Reassemble the circuit block.</p>	<p>※ Install the parts in the number order shown in the illustration below, paying attention to the following: mounting positions, direction of mounting.</p>
---	---

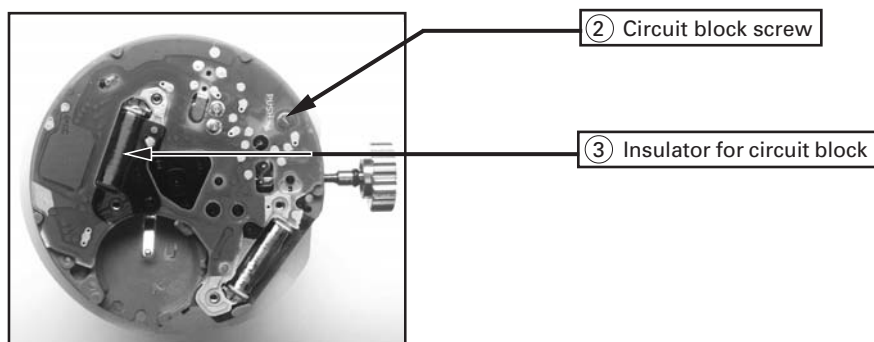
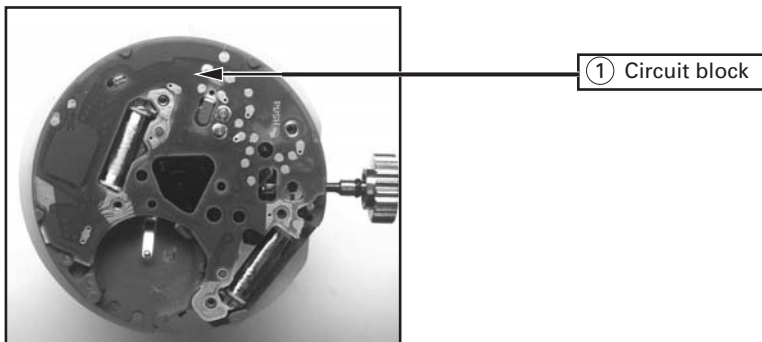

<p>Reassembly (7) Reassemble the switch lever.</p>	<p>※ Install the parts in the number order shown in the illustration below, paying attention to the following: mounting positions, direction of mounting.</p>
--	---

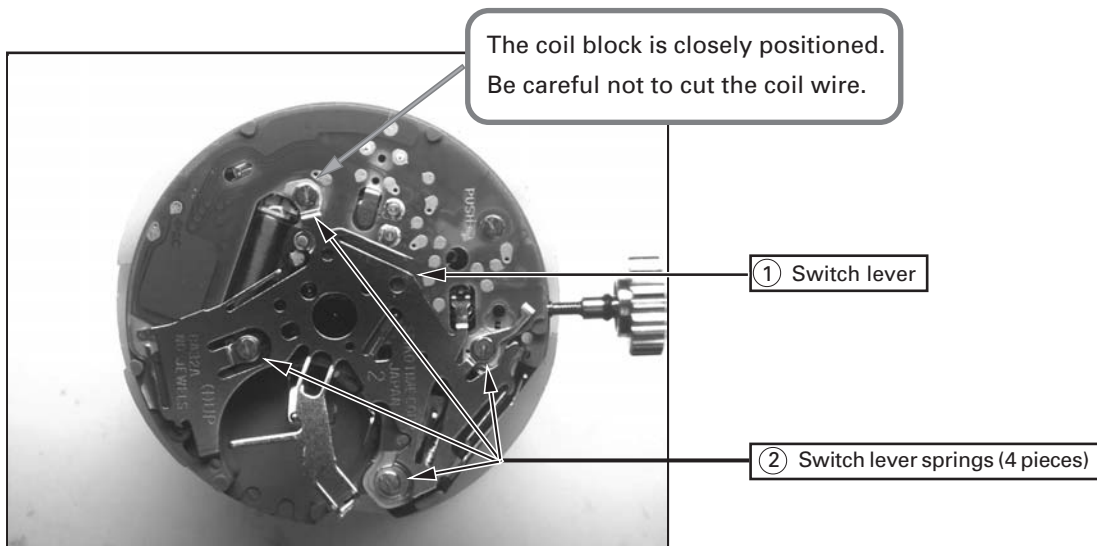

## Installation positions • Lubrication points • Remarks

Reassembly (8)  
Reassemble the wheels on the back side

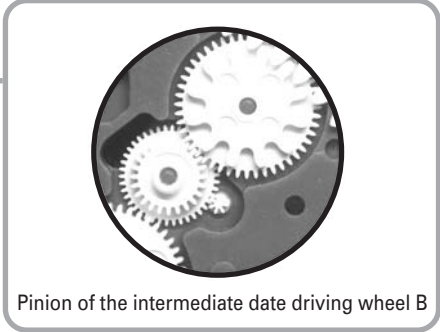
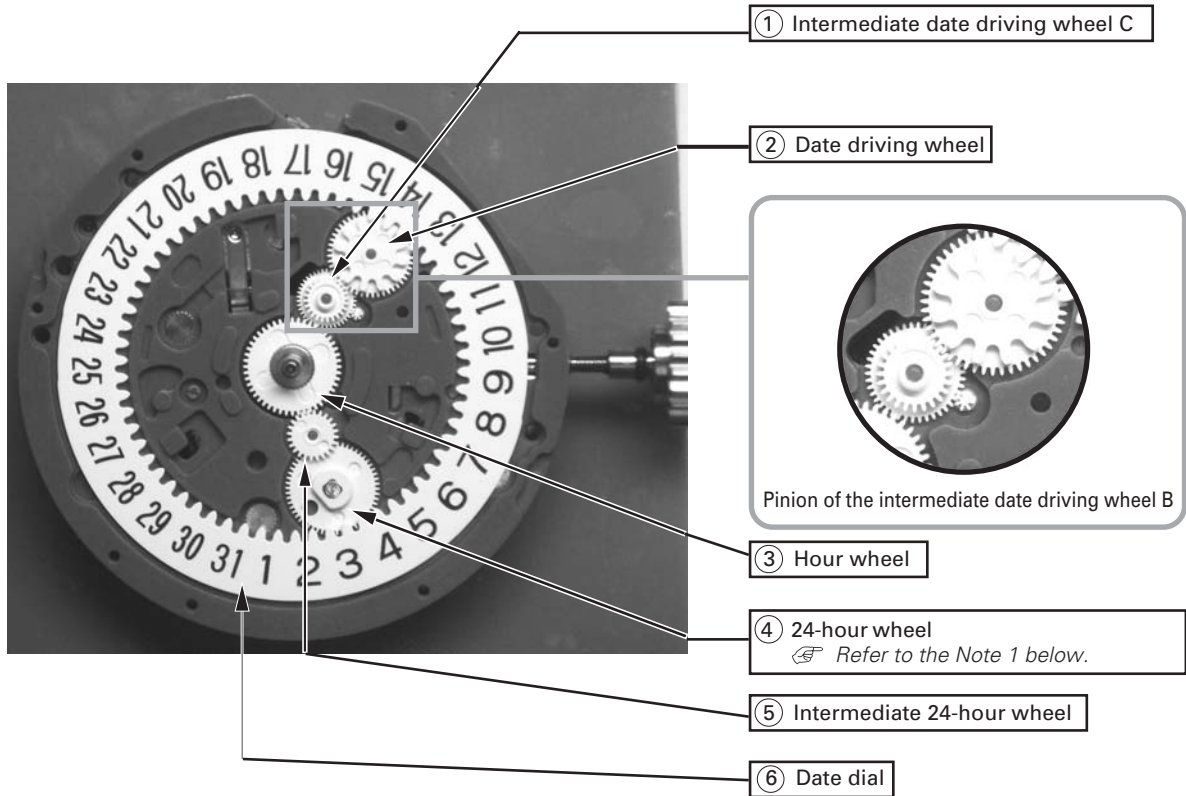

*☞ Note 1*

### 24-hour wheel

**CAUTION!**

Make sure that the 24-hour wheel is set in the correct direction.  
Ensure that the flattened side is positioned properly as shown in the illustration.



- When mounting the plastic parts, carefully check that the teeth of the wheels and pinions are properly engaged before setting the parts.
- Use a pair of tweezers to securely hold the plastic parts, paying attention so as not to damage the teeth or pinions.



## Installation positions • Lubrication points • Remarks

Reassembly (9) Reassemble the date dial guard.	* Install the parts, paying attention to the following: mounting positions, direction of mounting.
---	--

The date dial guard is fastened at the three positions (A, B and C) that are engaged with the date dial guard fixing guards and guide pins of the main plate.

### <Reassembly>

1. Turn the date dial guard clockwise until it is halfway engaged with the date dial guard fixing guards at the A, B and C positions each.
2. While further turning the date dial guard clockwise, press the date dial guard guide holes toward the guide pins of the main plate at the A and B positions until the date dial guard fixing guards are completely engaged with the main plate.

### <Disassembly>

1. Using a pair of tweezers, lift the A position of the date dial guard to disengage the date dial guard guide hole and the guide pin of the main plate. Turn the date dial guard counterclockwise until it overrides the guide pins of the main plate.
2. Using a pair of tweezers, lift the B position of the date dial guard to disengage the date dial guard guide hole and the guide pin of the main plate. Turn the date dial guard counterclockwise until it overrides the guide pins of the main plate.
3. Turn the date dial guard counterclockwise until it is disengaged from the date dial guard fixing guards of the main plate. And then remove the date dial guard.

Date dial guard fixing guard  
(C positions)

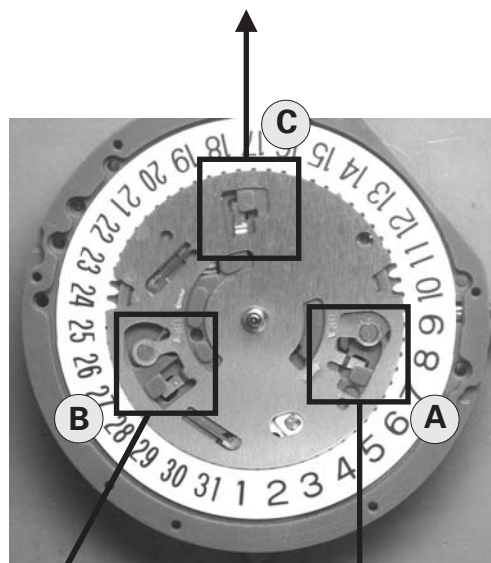
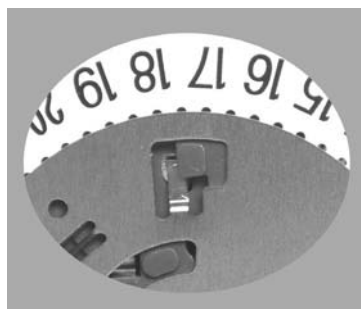

Guide pin (B position)

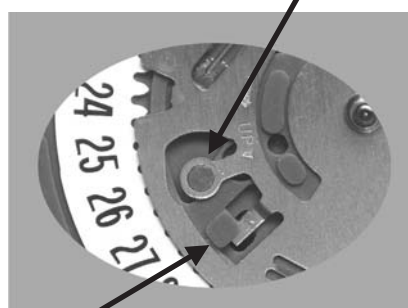

Date dial guard fixing guard (B positions)

Guide pin (A position)

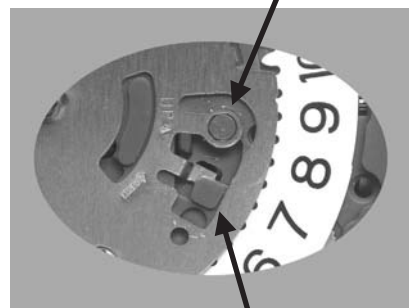

Date dial guard fixing guard (A positions)

## VALUE CHECKING

### ● Coil block resistance

1.28 - 1.48k $\Omega$

#### [Measuring the coil block resistance]

1. Measure the resistance with the coil block installed on the main plate.
2. Apply the red and black probes of the tester to the patterns of the coil lead terminal. While doing so, take care not to touch the end portion of the coil lead terminal, as this may break the coil wire.

### ● Current consumption

For the whole movement: less than 1.61 $\mu$ A

For the circuit block alone: less than 0.3  $\mu$ A

#### [Measuring the current consumption for the whole movement]

1. Apply the red probe of the tester to the pattern of the positive (+) terminal of the circuit block and the black probe of the tester to the pattern of the negative (-) terminal of the coil block.
2. After connecting the tester, wait for approximately one minute until the current consumption becomes stable. When the current consumption shows stable measurements, read the measurement.

#### [Measuring the current consumption for the circuit block alone]

1. Connect the tester to the positive (+) and negative (-) input terminals of the circuit block. Wait for approximately one minute until the current consumption becomes stable. When the current consumption shows stable measurements, read the measurement.

\* Light may increase the current consumption, resulting in an inaccurate measurement. Protect the movement from light with a black cloth or similar, and take a measurement again.

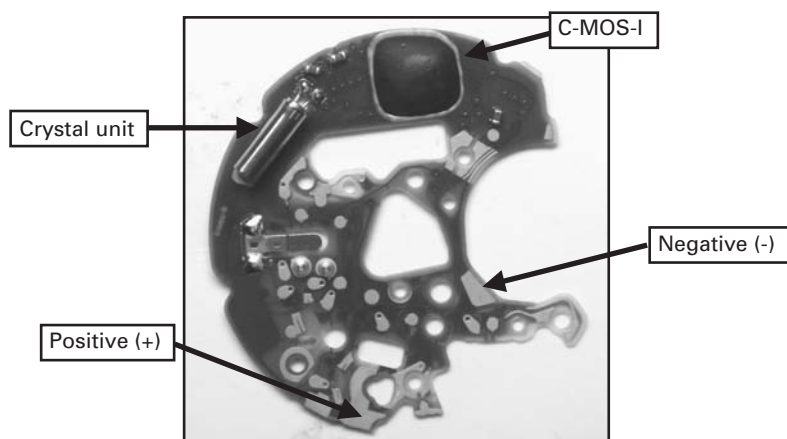

### CAUTION

When the current consumption for the whole movement exceeds the standard value, measure the current consumption for the circuit block alone. If the current consumption for the circuit block alone is within the standard value range, a driving pulse may be generated. In that case, overhaul and clean the movement parts, and then measure the current consumption for the whole movement again.

### ● Checking the accuracy

In order to check the accuracy, set the gate time of the quartz tester to 10 seconds, and measure the accuracy with the crown at the original position.



## Installation positions • Lubrication points • Remarks

Reassembling the exterior parts (1)  
Set the battery.

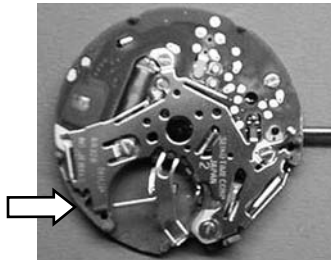

Clip of the battery holder

1. Slide the battery in the direction shown by the arrow in the illustration (with the positive side facing up.)
2. Attach the clip to the battery holder.

\* If the clip of the battery holder is attached to the main plate, take it off.

Reassembling the exterior parts (2)  
Set the dial.



Positions of the slots on the main plate  
(two positions)



1. Check the two positions of the slots on the main plate and the position of the calendar frame of the dial. Place the dial temporarily.
2. Align the dial properly and firmly press it down to set it.

Reassembling the exterior parts (3)  
Set the hour hand, minute hand and second hand.



### How to set the hour hand

1. Pull out the crown to the second click position and turn it clockwise to advance the hour hand. Stop the hour hand at the moment the date changes.
2. Set the hour hand pointing to the 12 o'clock position.
  - Press it down to the surface of the hour wheel.
  - Exercise care so as not to damage the arbors of the minute wheel and fourth wheel.
3. Make sure that there is no friction between the hour hand and the dial. Adjust the height of the hour hand if necessary.



## How to set the minute hand

1. Temporarily set the minute hand pointing to the 12 o'clock position.
2. Turn the crown counterclockwise at the second click position to move the minute hand backward passing the 9 o'clock position, and then turn the crown clockwise to move the minute hand forward in order to check the timing when the date changes. In a case that the date changes at a time out of the target time of the date change, remove the minute hand and mount it again.
3. Firmly press the minute hand down to set it.
  - Press the minute hand down to the surface of the center wheel, but be careful not to press it excessively.
  - Exercise care so as not to damage the arbor of the fourth wheel.
  - Target time of the date change: between 23:00 and 01:00
4. Make sure that there is no friction between the minute hand and the hour hand, between the minute hand and the markers on the dial, and between the minute hand and the calendar frame. Adjust the height of the minute hand if necessary.



## How to set the second hand

1. Align the second hand so as to position the tip at the center of the width of the graduation marker, and slightly press it down to set it temporarily.
2. Push the crown back to the original position and check the sweep of the second hand.
  - In a case that the second hand movement shows a large deviation from the graduation, remove the second hand and set it again.
3. After confirming that the second hand sweeps along with the graduation, pull out the crown to the second click position to stop the second hand movement, and then firmly press it down to set it.
  - Press the second hand down adequately without pushing it insufficiently or excessively.



## Hand installation check ups

1. Ensure that there is an adequate clearance between the dial and the hour hand, between the hour hand and the minute hand, and between the minute hand and the second hand. Also check that the second hand is slightly curved upward. Make sure that there is no friction. Adjust the position of the height of the hands if necessary.

## HOW TO INPUT THE CALENDAR DATA (1)

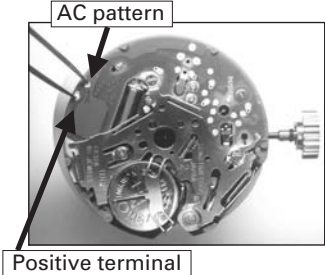
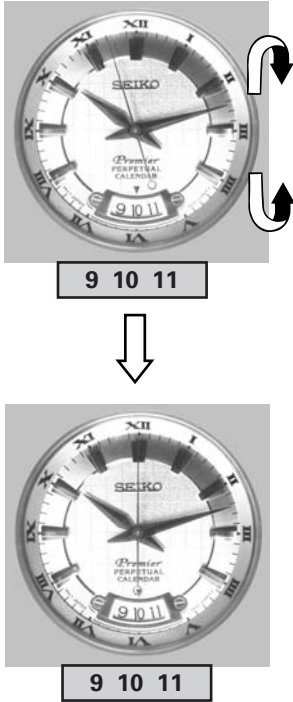
	Method of operation	Illustration	Notes and tips
1	Set the inner frame.		When fixing in the inner frame, take care so as not to touch the circuit pattern.
2	<b>Reset the IC (Integrated circuit.)</b> <ul style="list-style-type: none"> <li>• Keep the positive terminal in contact with the AC pattern of the circuit for 4 seconds or longer to reset the IC.</li> <li>* Make sure the crown is at the original position.</li> </ul>		
3	Close the back lid.		Make sure that the gasket is not pinched or rolled.
4	<b>Initial position adjustment for the calendar (1)</b> (Set the second hand pointing to the 12 o'clock position.) <ol style="list-style-type: none"> <li>1. Pull out the crown to the first click position and hold down the button for 2 seconds or longer.                             <ul style="list-style-type: none"> <li>* The second hand will rapidly turn clockwise and stop and the date dial will move back and forth, and then stop.</li> <li>* Keep the crown at the first click position from this point onward.</li> </ul> </li> <li>2. After confirming that the second hand and the date dial have been stopped, turn the crown to set the second hand pointing to the 12 o'clock position.</li> </ol> <p><b>"Initial position of the second hand"</b></p> <ul style="list-style-type: none"> <li>* Make sure that the second hand movement is interlocked with the rotation of the crown: the second hand moves forward by turning the crown clockwise, while it moves backward by turning the crown counterclockwise.</li> </ul>		Rotating the crown clockwise will turn the second hand clockwise.  Rotating the crown counterclockwise will turn the second hand counterclockwise. <ul style="list-style-type: none"> <li>● In the following operations in each mode, never rotate the crown while the second hand and the date dial are moving, as this may cause an IC malfunction.</li> <li>* In a case that an IC malfunction occurs, reset the IC and follow the same procedures again for restoration.</li> <li>* If the watch is left unoperated in this mode, the setting mode will be automatically cancelled and the watch will return to the normal mode within 2 to 3 minutes.</li> </ul>

## HOW TO INPUT THE CALENDAR DATA (2)

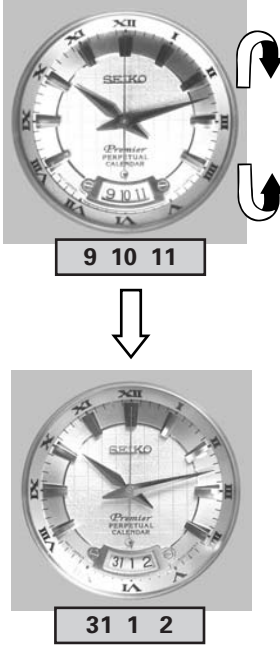
	Method of operation	Illustration	Notes and tips
5	<p><b>Initial position adjustment for the calendar (2)</b>                      (Set the date dial to show the numeral "1".)</p> <p>* Keep the crown at the first click position.</p> <ol style="list-style-type: none"> <li>Press the button once.                              The second hand will stop pointing to the 12 o'clock position, and the date dial will move back and forth, and then stop.</li> <li>After confirming that the date dial has been stopped, turn the crown clockwise rapidly until the date dial starts a self-propelling movement.</li> <li>At the moment when the numeral "1" appears in the calendar frame, slowly turn the crown counterclockwise to cancel the self-propelling movement of the date dial and stop it.</li> <li>And then slowly turn the crown clockwise or counterclockwise to align the numeral "1" in the center of the calendar frame.</li> </ol>	 <p>● Position of the date numeral after adjustment</p>	<p>Rotating the crown clockwise will move the date dial forward.</p> <p>Rotating the crown counterclockwise will move the date dial backward.</p> <ul style="list-style-type: none"> <li>Slowly turning the crown will move the date dial slowly.</li> <li>Rapidly turning the crown continuously will trigger the self-propelling movement of the date dial.</li> </ul> <p>* While the date dial is self-propelling, slowly turning the crown in the reverse direction of the date dial's movement will cancel the self-propelling movement of the date dial.</p> <p>* If the watch is left unoperated in this mode, the setting mode will be automatically cancelled and the watch will return to the normal mode within 2 to 3 minutes.</p>

## HOW TO INPUT THE CALENDAR DATA (3)

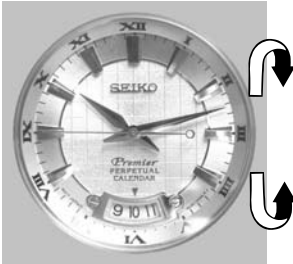
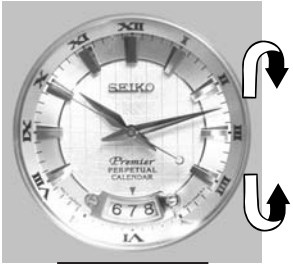
	Method of operation	Illustration	Notes and tips
<p><b>6</b></p>	<p><b>Set the date.</b></p> <ul style="list-style-type: none"> <li>* Keep the crown at the first click position.</li> </ul> <ol style="list-style-type: none"> <li>1. Press the button once.</li> </ol> <ul style="list-style-type: none"> <li>* The second hand will turn counterclockwise and stop pointing to the 9 o'clock position. The date dial will move back and forth, and then stop when the numeral "1" comes to the center of the calendar frame.</li> </ul> <ol style="list-style-type: none"> <li>2. After confirming that the date dial has been stopped, turn the crown clockwise rapidly until the date dial starts a self-propelling movement.</li> <li>3. At the moment when the date numeral you wish to set appears in the calendar frame, slowly turn the crown counterclockwise to cancel the self-propelling movement of the date indicator and stop it.</li> </ol>	 <p style="text-align: center;"><b>9 10 11</b></p> <p>When the date is the 10th, set the numeral to "10" in the center of the calendar frame.</p>	<p>Rotating the crown clockwise will move the date dial forward.</p> <p>Rotating the crown counterclockwise will move the date dial backward.</p> <ul style="list-style-type: none"> <li>• Slowly turning the crown will move the date dial slowly.</li> <li>• Rapidly turning the crown continuously will trigger the self-propelling movement of the date dial.</li> <li>* While the date dial is self-propelling, slowly turning the crown in the reverse direction of the date dial's movement will cancel the self-propelling movement of the date dial.</li> <li>* If the watch is left unoperated in this mode, the setting mode will be automatically cancelled and the watch will return to the normal mode within 2 to 3 minutes.</li> </ul>
<p><b>7</b></p>	<p><b>Set the month.</b></p> <ul style="list-style-type: none"> <li>* Keep the crown at the first click position.</li> </ul> <ol style="list-style-type: none"> <li>1. Press the button once.</li> </ol> <ul style="list-style-type: none"> <li>* The second hand will stop pointing to the 10 o'clock position. The date dial will move forward and stop when the numeral "1" comes to the center of the calendar frame.</li> </ul> <ol style="list-style-type: none"> <li>2. After confirming that the date dial has been stopped, turn the crown clockwise rapidly until the date dial starts a self-propelling movement.</li> </ol>	 <p style="text-align: center;"><b>6 7 8</b></p> <p>When it is July, set the numeral to "7" in the center of the calendar frame.</p>	<p>Rotating the crown clockwise will move the date dial forward.</p> <p>Rotating the crown counterclockwise will move the date dial backward.</p> <ul style="list-style-type: none"> <li>• Slowly turning the crown will move the date dial slowly.</li> </ul>

## HOW TO INPUT THE CALENDAR DATA (4)

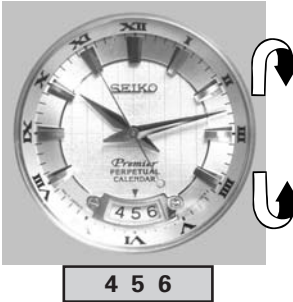



	Method of operation	Illustration	Notes and tips
	<p>3. At the moment when the month numeral you wish to set appears in the calendar frame, slowly turn the crown counterclockwise to cancel the self-propelling movement of the date dial and stop it.</p>		<ul style="list-style-type: none"> <li>• Rapidly turning the crown continuously will trigger the self-propelling movement of the date dial.</li> <li>* While the date dial is self-propelling, slowly turning the crown in the reverse direction of the date dial's movement will cancel the self-propelling movement of the date dial.</li> <li>* If the watch is left unoperated in this mode, the setting mode will be automatically cancelled and the watch will return to the normal mode within 2 to 3 minutes.</li> </ul>
<p><b>8</b></p>	<p><b>Set the year.</b></p> <ul style="list-style-type: none"> <li>* Keep the crown at the first click position.</li> </ul> <p>1. Press the button once. The second hand will rapidly turn forward pointing to the 11 o'clock position. The date dial will move forward and stop when the numeral "5" appears in the calendar frame.</p> <p>2. After confirming that the date dial has been stopped, turn the crown to set the numeral showing the last two digits of the year you wish to set.</p> <ul style="list-style-type: none"> <li>* The second hand remains pointing to the 11 o'clock position.</li> <li>* In this mode, the year is indicated by the numeral of the date dial up to the year 2031. (The year is indicated by the last two digits of the year; between 5 and 31.)</li> <li>* For the year 2032 and afterwards, refer to the year indication table.</li> </ul>	 <p>When it is the year 2005, set the numeral to "5" in the center of the calendar frame.</p>	<p>Rotating the crown clockwise will move the date dial forward.</p> <p>Rotating the crown counterclockwise will move the date dial backward.</p> <ul style="list-style-type: none"> <li>• Slowly turning the crown will move the date dial slowly.</li> <li>• Rapidly turning the crown (pressing the button continuously) will trigger the self-propelling movement of the date dial.</li> <li>* While the date dial is self-propelling, slowly turning the crown in the reverse direction of the date dial's movement will cancel the self-propelling movement of the date dial.</li> </ul>

## HOW TO INPUT THE CALENDAR DATA (5)

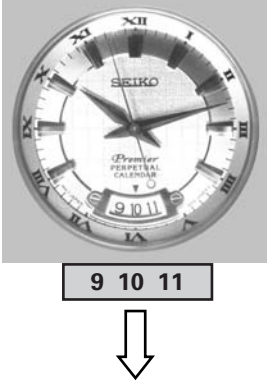

	Method of operation	Illustration	Notes and tips
			<p>* If the watch is left unoperated in this mode, the setting mode will be automatically cancelled and the watch will return to the normal mode within 2 to 3 minutes.</p>
9	<p>Push the crown back into the original position.</p>		<ul style="list-style-type: none"> <li>• The hour, minute and second hands will start moving.</li> <li>• The date dial will start moving and stop when the current date numeral appears in the calendar frame.</li> </ul>



## HOW TO CHECK THE CALENDAR SETTINGS (1)

	Method of operation	Illustration
<p><b>1</b></p>	<p><b>How to check the initial setting position of the calendar (1)</b></p> <p>To verify the second hand pointing to the "12 o'clock position"</p> <ol style="list-style-type: none"> <li>1. Pull out the crown to the first click position. Hold down the button for 2 seconds or longer.                             <ul style="list-style-type: none"> <li>• The second hand will rapidly move forward and stop pointing to the 12 o'clock position. The date dial will move forward and stop showing the numeral "1" in the calendar frame.</li> </ul> </li> </ol> <p>(Keep the crown at the first click position from this onward.)</p>	 
<p><b>2</b></p>	<p><b>How to check the initial setting position of the calendar (2)</b></p> <p>To verify the date numeral showing "1" in the calendar frame.</p> <ul style="list-style-type: none"> <li>* Keep the crown at the first click position.</li> </ul> <ol style="list-style-type: none"> <li>1. Press the button once.                             <ul style="list-style-type: none"> <li>• The date dial will move back and forth, and then stop showing the numeral "1" in the calendar frame.</li> </ul> </li> </ol> <p>(The second hand remains pointing to the 12 o'clock position.)</p>	
<p><b>3</b></p>	<p><b>How to check the initial position of the date numeral</b></p> <ul style="list-style-type: none"> <li>* Keep the crown at the first click position.</li> </ul> <ol style="list-style-type: none"> <li>1. Press the button once.                             <ul style="list-style-type: none"> <li>• The second hand will rapidly move back and stop pointing to the 9 o'clock position. The date dial will move forward and stop showing the set date numeral at the initial position in the calendar frame.</li> </ul> </li> <li>* If the date numeral and the month numeral are the same, the date dial will swing back and forth, and then stop showing the date numeral at the initial position in the calendar frame.</li> </ol>	

## HOW TO CHECK THE CALENDAR SETTINGS (2)

	Method of operation	Illustration
4	<p><b>How to check the initial position of the month numeral</b></p> <ul style="list-style-type: none"> <li>* Keep the crown at the first click position.</li> </ul> <ol style="list-style-type: none"> <li>1. Press the button once.                     <ul style="list-style-type: none"> <li>• The second hand will rapidly move forward and stop pointing to the 10 o'clock position. The date dial will move forward and stop showing the month numeral at the initial position in the calendar frame.</li> </ul> </li> </ol> <ul style="list-style-type: none"> <li>* If the month numeral and the year numeral are the same, the date dial will swing back and forth, and then stop showing the month numeral at the initial position in the calendar frame.</li> </ul>	 <p style="text-align: center;">6 7 8</p>
5	<p><b>How to check the initial position of the year</b></p> <ul style="list-style-type: none"> <li>* Keep the crown at the first click position.</li> </ul> <ol style="list-style-type: none"> <li>1. Press the button once.                     <ul style="list-style-type: none"> <li>• The second hand will rapidly move forward and stop pointing to the 11 o'clock position. The date dial will move forward and stop showing the year numeral at the initial position in the calendar frame.</li> </ul> </li> </ol> <ul style="list-style-type: none"> <li>* If the year numeral and the month numeral are the same, the date dial will swing back and forth, and then stop showing the year numeral at the initial position in the calendar frame.</li> </ul> <p>(The year is indicated by the last two digits of the year: between 5 and 31.)</p>	 <p style="text-align: center;">4 5 6</p>
6	<p><b>Push the crown back into the original position.</b></p>	<ul style="list-style-type: none"> <li>• The hour, minute and second hands will start moving.</li> <li>• The date dial will start moving and stop when the current date numeral appears in the calendar frame.</li> </ul>